

Fernmelde-Anschlusskasten

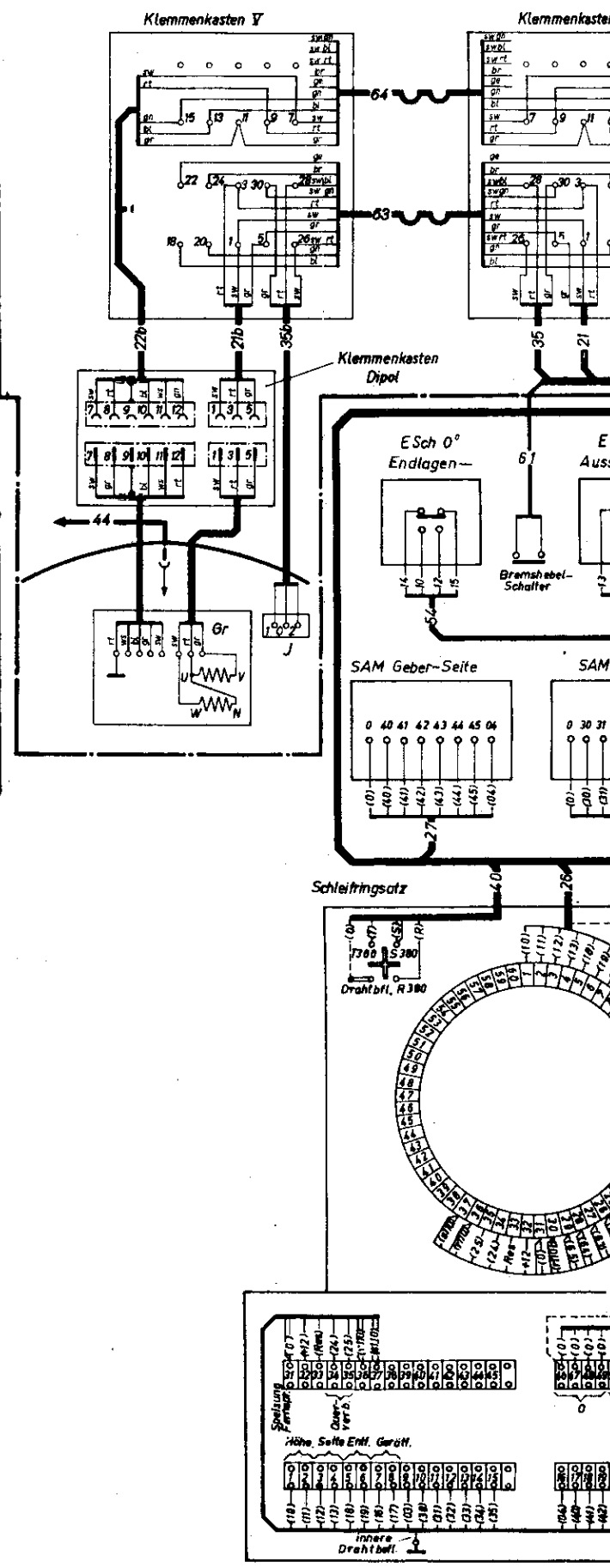

Kasten IV

Klemmenkast

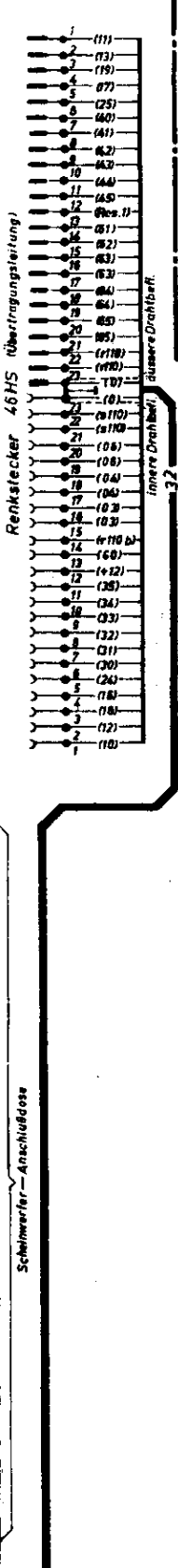
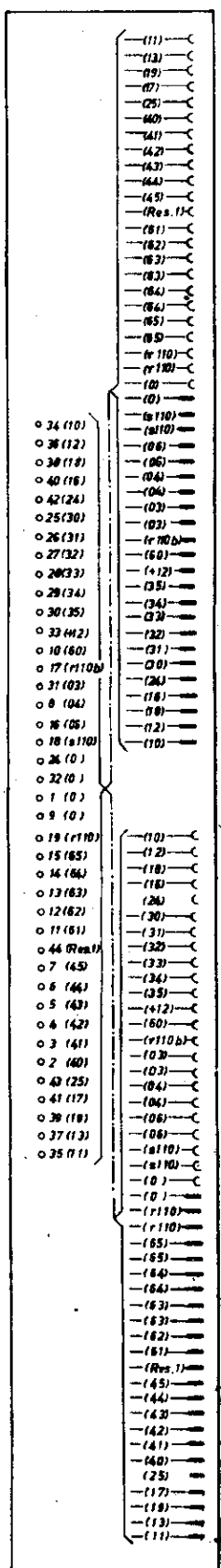
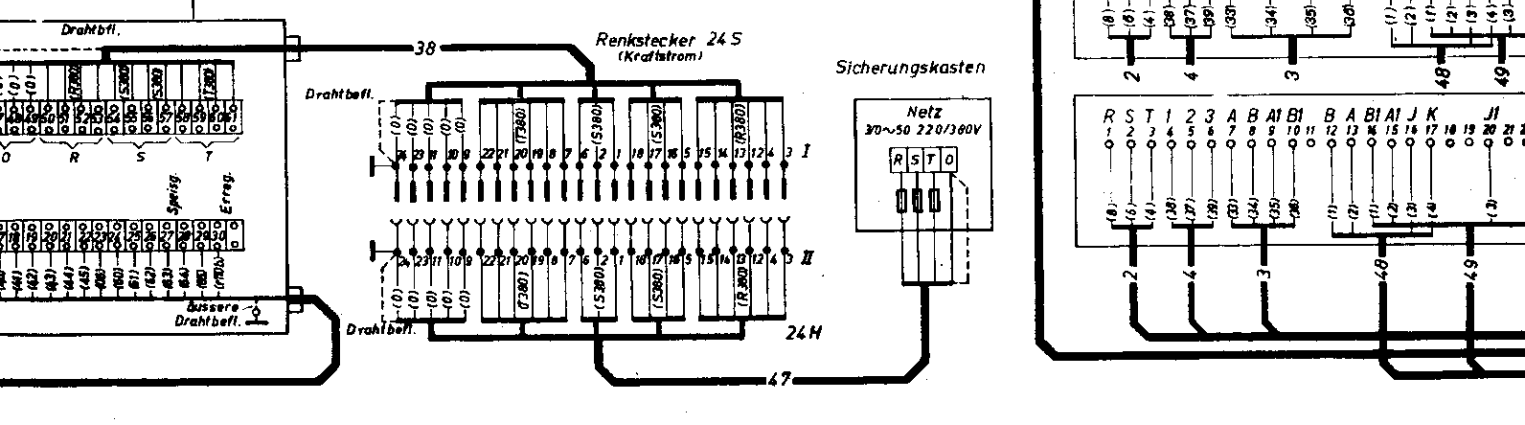
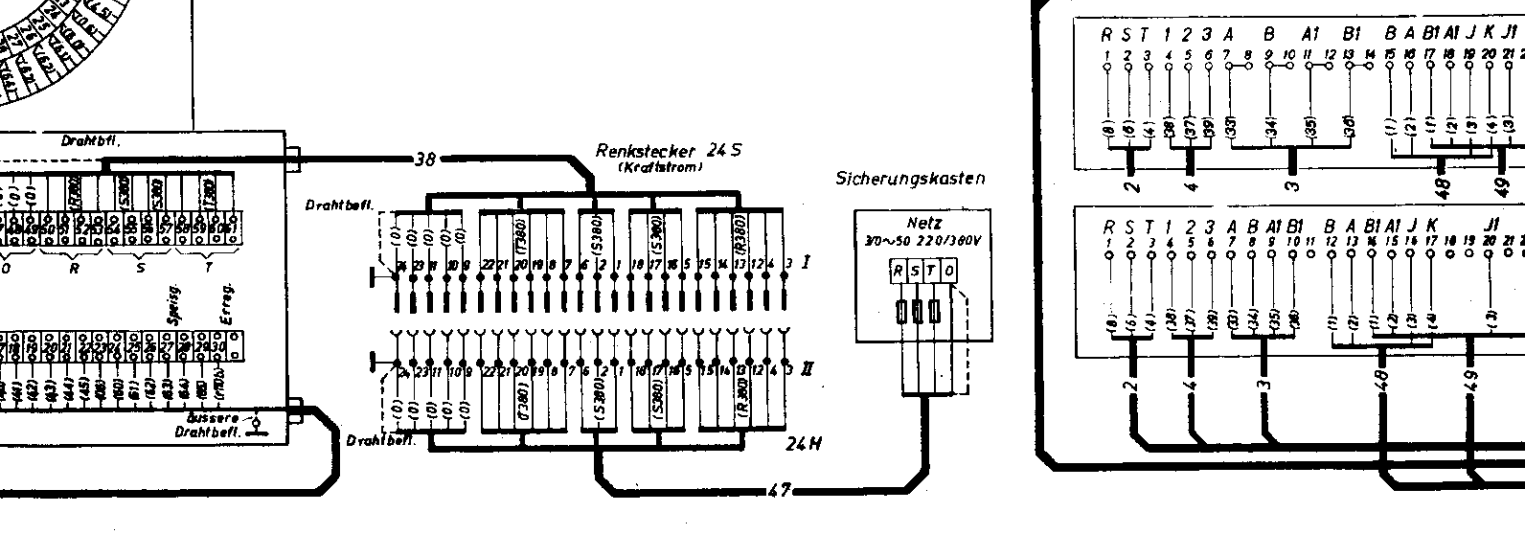
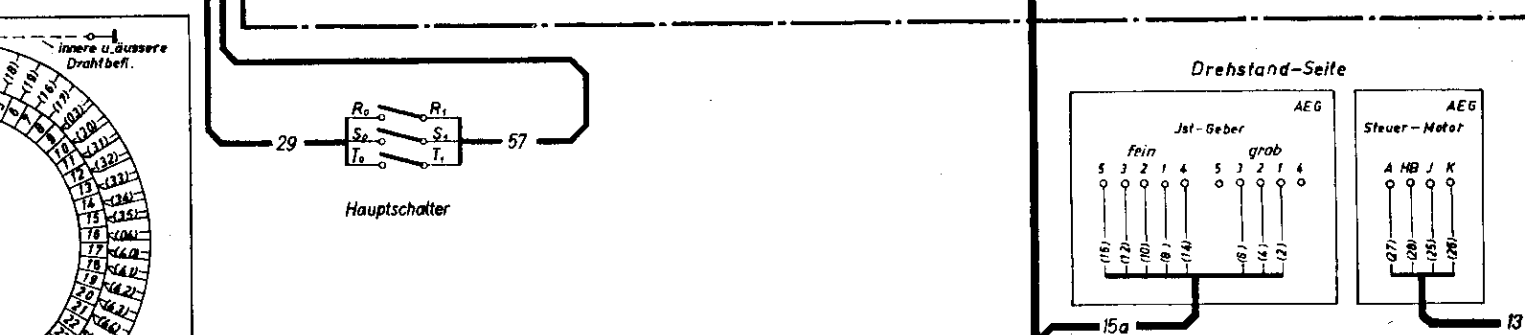
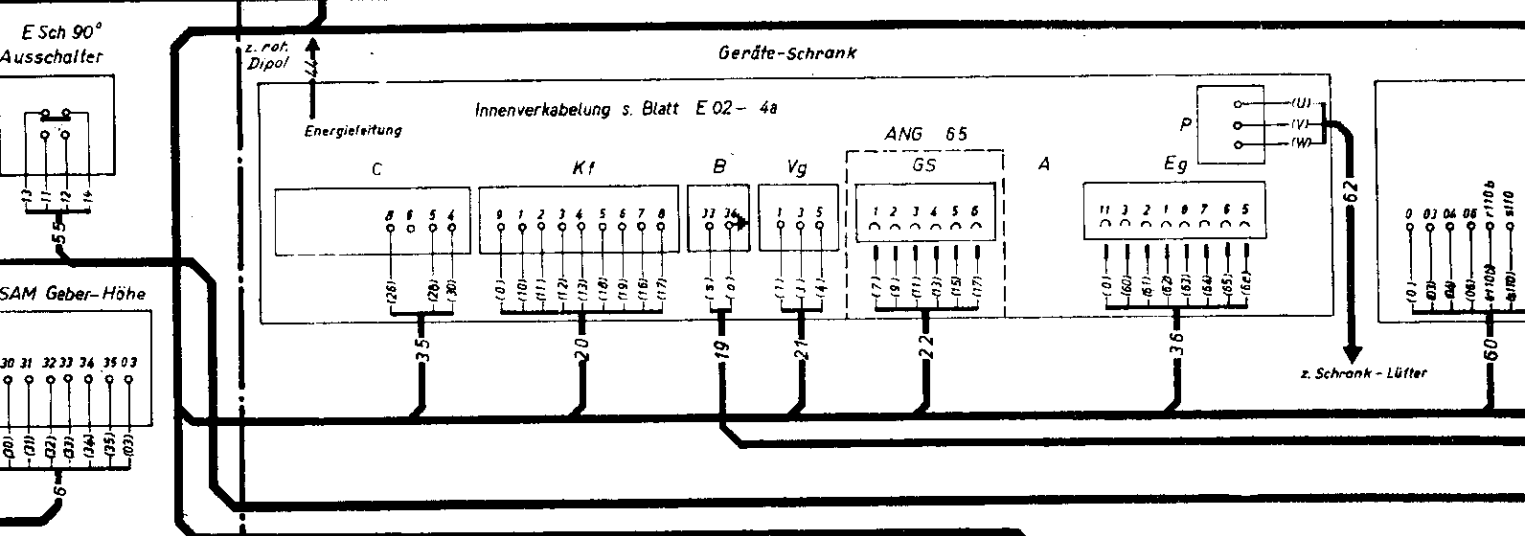
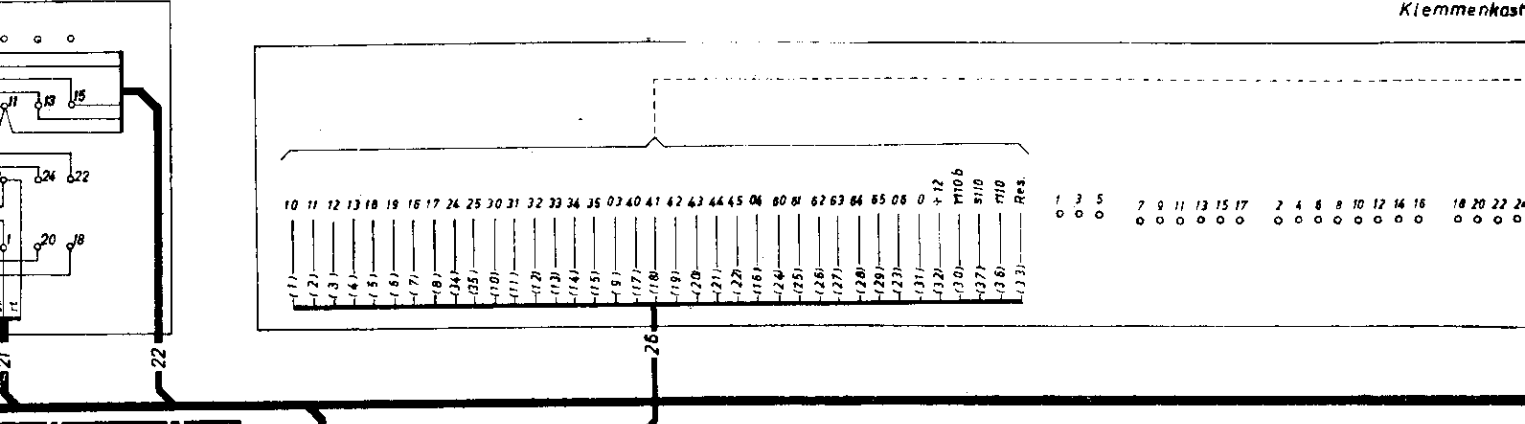

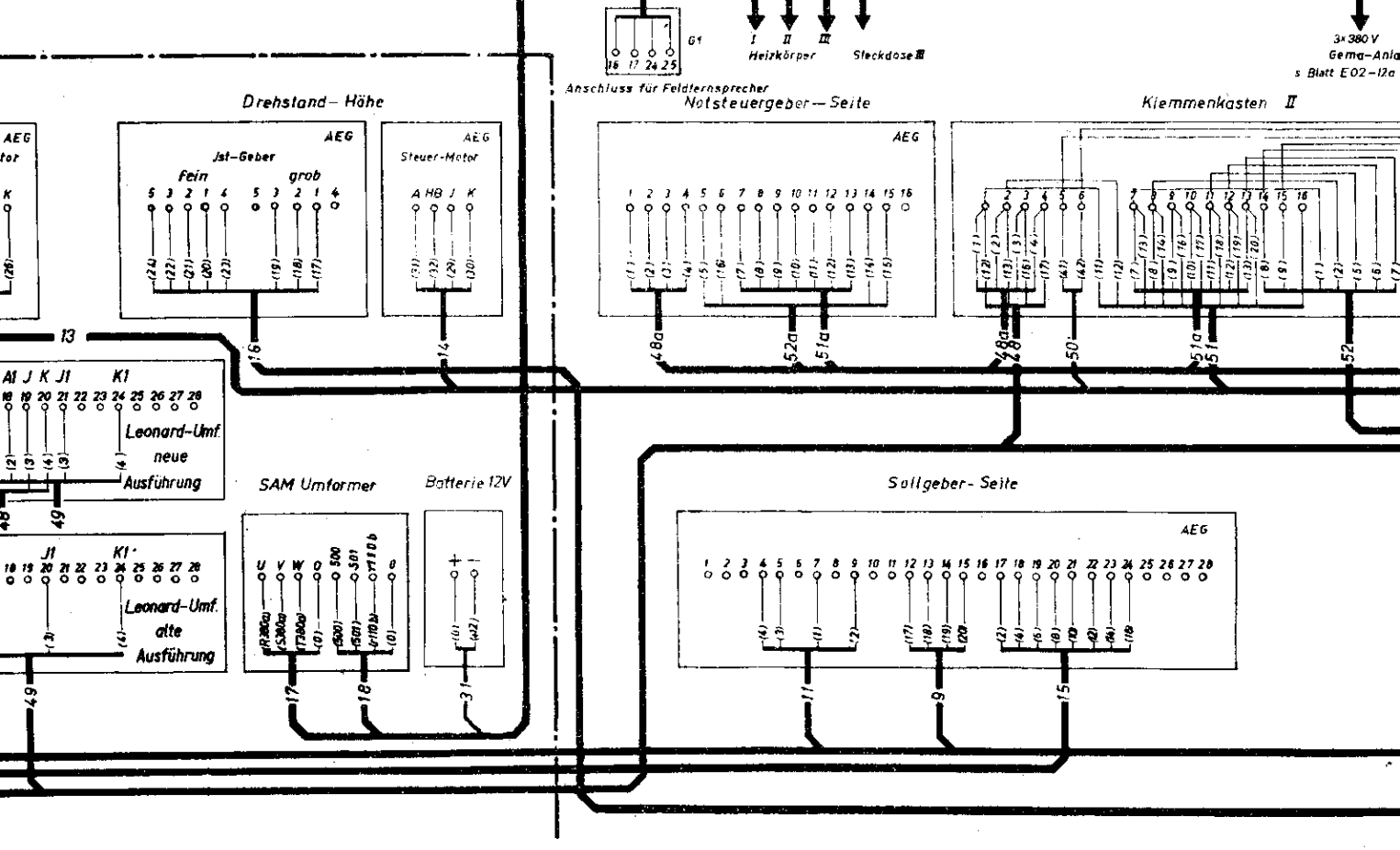
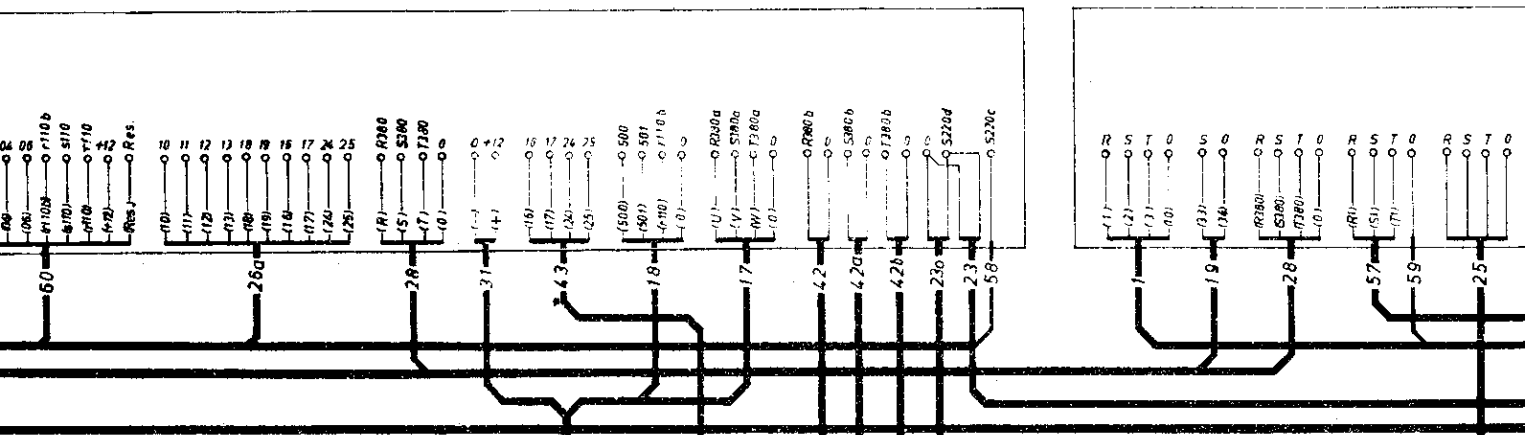
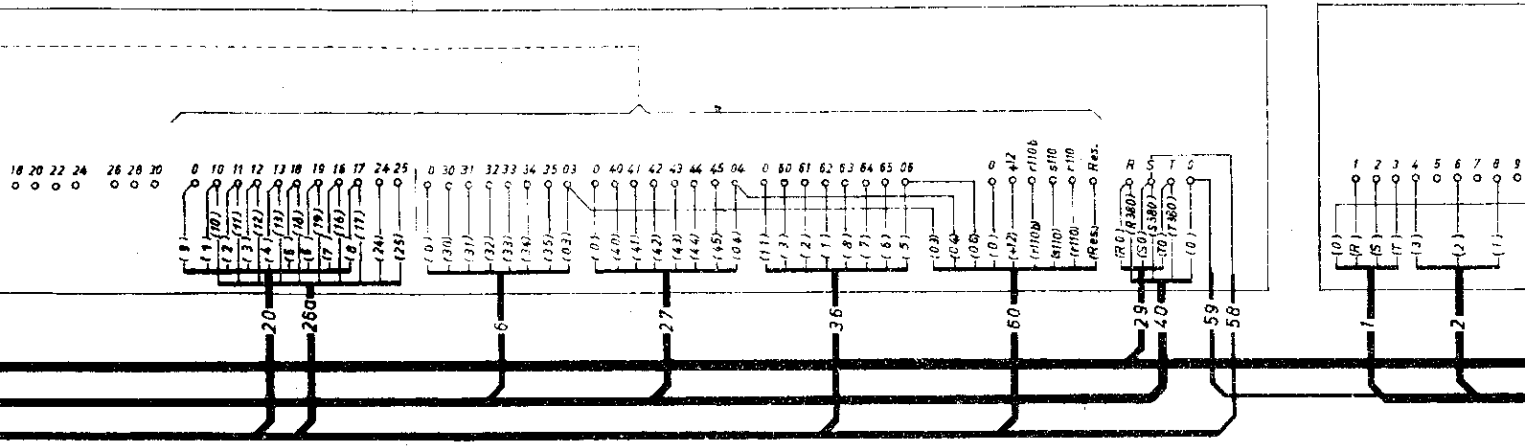

Schaltkasten Schk 3a

Verstärkerkasten Vk 10a

AEG

AEG

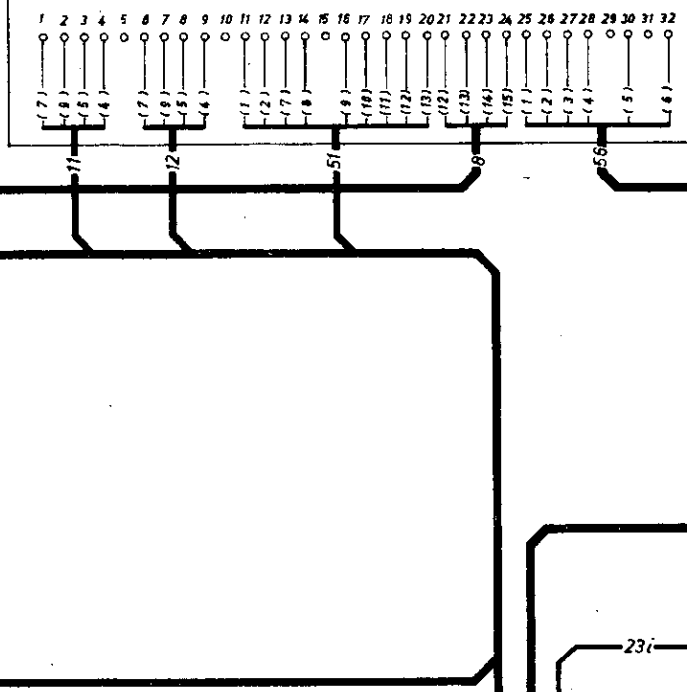
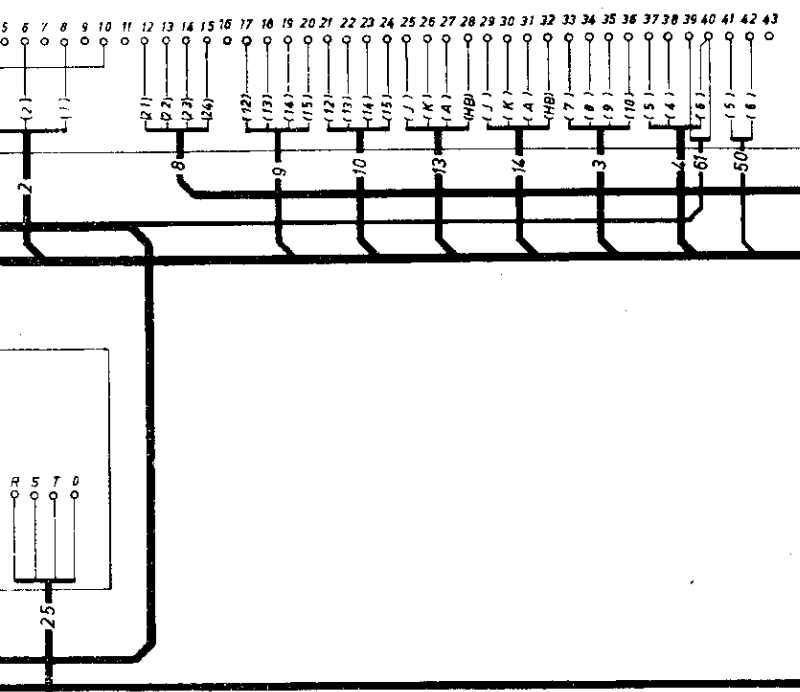

3x380V  
Gema-Anlage  
statt E02-12a und E02-12b

Klemmenkasten III

Notsteuergeber-Höhe

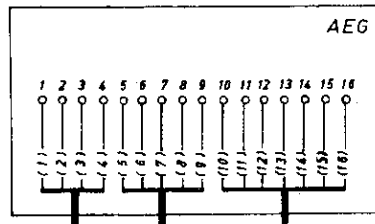
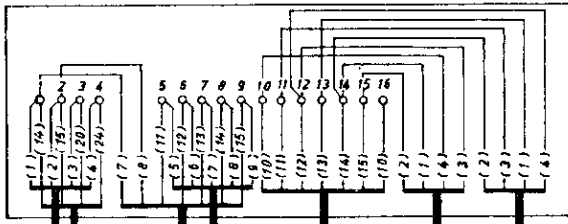
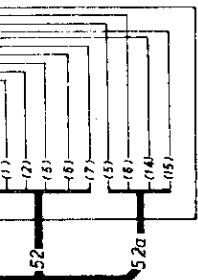

Sollgeber-Höhe

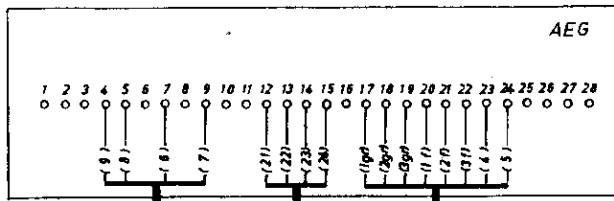

Lampe Höhen

Werkstattbuch

Nr. 069

# FuMG 65 (FuSE 65) Schaltplan der Gesamtanlage Ausführung mit Klemmenkästen IV und V

# E 02-3d

XX/44

Verstärkerkasten Vk 10a

Spannungsregler

